



**ESP 300L
ECOCENT MAXI**

**INSTALLATION AND OPERATION
MANUAL**

WARNING !

READ THIS BEFORE INSTALLING THE UNIT

All un-vented water heating systems above 15 litres (this includes the ESP Ecocent Hot Water ASHPs) MUST be installed to meet the requirements of the local area Building Regulations. It is a legal requirement that the local Building Control Officer be notified of any proposed installation of un-vented water heating systems over 15 litre capacity. This Ecocent unit must be installed and operated in accordance with EN 806.

Furthermore, it must be fitted by an installer who has successfully completed a recognised course in the installation of un-vented heating systems such as CITB and be familiar with installing the Ecocent unit. Failure to properly fit the unit may affect its safety, efficiency and invalidate any guarantee.

Safety requirements in the UK call for an expansion space (internal or external), safety devices to prevent the stored water exceeding 100°C and pipe work to convey discharged hot water safely away from the safety devices.

THE UNIT MUST BE INSTALLED, COMMISSIONED AND MAINTAINED BY A COMPETENT INSTALLER IN ACCORDANCE WITH BUILDING REGULATION G3 (ENGLAND AND WALES), TECHNICAL STANDARD P3 (SCOTLAND) OR BUILDING REGULATION P5 (NORTHERN IRELAND) AND THE WATER FITTING REGULATIONS (ENGLAND AND WALES) OR WATER BYELAWS (SCOTLAND). FOLLOWING INSTALLATION AND COMMISSIONING, THE OPERATION OF THE UNIT SHOULD BE EXPLAINED TO THE USER AND THESE INSTRUCTIONS LEFT WITH THEM FOR FUTURE REFERENCE.

Contents Page

1.0	Preface
2.0	General Notes
2.1	Safety Precaution
2.2	Installation Notes
2.3	Operating Notes
2.4	Move and Repair notes
2.5	Operation Notes
2.6	Overheat Protection
2.7	General Requirements
3.0	Component Checklist
4.0	Sitting the Unit
4.1	Some notes on Ducting
4.2	Water Supply
4.3	Outlet/Terminal fittings
4.4	Limitations
4.5	Hot Water ASHP Package
4.6	Basic system schematic
5.0	Specification
5.1	Appearance
5.2	Dimensions
5.3	Specifications
5.4	Performance
5.4.1	Performance assumptions
5.5	DHW Recovery Times
6.0	Installation
6.1	Installation Sketch Map
6.2	Indirect Thermal cut-out (dual stat)
6.3	Pipe fittings
6.4	Cold Water Supply
6.5	Cold Water Combination Valve
6.6	Drain Cock
6.7	Outlet Pipe Work
6.8	Secondary Circulation of DHW
6.9	TPRV
6.10	Warnings
6.11	Discharge Pipe Work
6.12	Expansion Vessel
6.13	G3 Requirement
6.14	G3 Guidance Section

7.0	How to connect to the Heat Pump
7.1	Insulation Treatment
7.2	Wiring
7.3	Earthing
7.4	Unit System Controls
7.5	Immersion Heater
8.0	Operation
8.1	Control panel explanation
8.2	Display Explanation
8.3	Before running the unit
8.4	Mode Selection
8.5	Setting the Water temperature
8.6	Setting the Clock
8.7	Setting the Timer
8.8	Setting Vacation Mode
8.9	Setting the timer
8.10	Using the Immersion Heater
8.11	Setting the Fan Speed
8.12	Locking the Keypad
8.13	User Operating Parameters
9.0	Maintenance Requirements for the Cylinder
9.1	Checking operation of safety valves
9.2	Cleaning the Strainer
9.3	Draining the Unit
9.4	Descaling the immersion heater
9.5	Refilling the system
9.6	Log Book
9.7	Maintenance Requirements
10.0	Simple Fault Finding
10.1	FAQs
11.0	Guarantee
11.1	Guarantee Terms
12.0	Environmental Information
13.0	Spare Parts
14.0	Factory Set Parameters

1.0 PREFACE:

This manual includes the necessary information about installation and maintenance of the EcoCent. Please read this manual carefully before you install or carry out maintenance on the unit.

When installing the unit, please carry out the work strictly in accordance with the manual, relevant Regulations and good practice.

Please do not switch the unit on until you are sure that it has been properly installed (both electrically and mechanically), there is water in the system and the tank has been completely purged of air.

The installer *must* explain to the end user how to operate and maintain the unit before handing over the unit to the end user.

The installer *must* advise the end user to read the manual fully before operating the unit and leave this manual with the end user.





Further, improper installation, operation and/or maintenance, and failure to maintain the unit as per this manual will invalidate any unit warranty or guarantee.

The manual may be altered and/or updated in any way at the sole discretion of the supplier and/or ESP without notice.







2.0 GENERAL NOTES

2.1 Safety Precautions





Below you will find information that is critical for the safe and proper installation and the use of the unit. Please make sure that you understand the contents to help avoid the risk of injury or damage to the unit/other property.

Icon	Meaning
	Wrong operation may lead to risk to life or serious injury.
	Potential danger to you or others.
	Prohibited.
	Compulsory.





2.2 Installation Notes

	Professional & qualified installer is required	The heat pump must only be installed by a suitably qualified engineer. Failure to ensure this can cause damage to the unit and may cause serious injury. The warranty on the unit will also be invalidated if a suitably qualified engineer is not engaged to install it.
	Earthing Required	Please make sure that the unit and power supply are properly earthed.
	Refrigerant	If you are installing the unit in a small room, please give careful consideration to adequate ventilation being available in the event of a refrigerant leak.
	Installation Site	Do not install the unit near to a gas installation. This unit is designed to be installed inside a building.
	Site consideration	Ensure that this unit is installed on a solid, level floor. Make sure that you have a suitable facility to cater for disposal of condensate from the condensate drain on the unit.
	Circuit Breaker	Make sure that this unit is connected to the power supply via a suitably sized MCB.
	Unit Upright	The unit <u>must</u> be installed level across the whole diameter. Failure to install the unit level will mean that condensate can spill over the lip of the cylinder.



2.3 Notes on Operating your EcoCent:

	Read the Manual	Read this entire manual before attempting to install or operate this unit.
	Do NOT	Do not push anything into the fan blades when running and make sure that children cannot access the unit or play close to the unit.
	Children	Children should only operate this unit under the supervision of adults.
	Shut off the power supply	If there is an unusual sound or smell coming from the unit, shut off the power supply immediately and call your installation engineer.

2.4 Notes on moving and repairing your EcoCent:

	Caution	This unit has a high centre of gravity. This EcoCent must be secured to prevent it falling over when in transit.
	Suitably qualified engineer	When moving the unit or carrying out repair work please be sure to use only a suitably qualified engineer.
 	Do NOT	Do NOT try to install, move or repair the unit yourself – it is NOT worthwhile running the risk of injury.
	Transporting the Unit	The unit must be transported in the vertical position. It can be tilted up to a maximum 30° from the vertical axis.

2.5 Some Safety Notes:

	Siting the Unit	The unit must only be installed indoors – the unit is neither designed for, nor suitable for, installation outside. The Unit needs to be sited where the ambient temperature never goes below 5 degrees. If the unit is to be left unused for any significant period of time during which the ambient temperature could cause the unit or pipe work from the unit to freeze, it should be drained down.
	Shut off the power	When cleaning the unit, shut off the power supply.
	Power Supply	You must use a suitable power supply that is appropriately Fused and protected by an RCD.

2.6 Overheat Protection.

This unit is protected from the risk of overheating by a circuit that will isolate the electrical supply in the unlikely event of overheating. Once the temperature of the stored water has returned to normal, the unit must be reset as follows:



2.7 General Requirements



IMPORTANT: PLEASE READ AND ENSURE THAT YOU UNDERSTAND THESE INSTRUCTIONS BEFORE INSTALLING THE ESP ECOCENT (“DHW ASHP” OR “UNIT”). INCORRECT INSTALLATION WILL INVALIDATE ANY GUARANTEE AND MAY BE DANGEROUS.



PLEASE NOTE THAT THERE ARE ESSENTIALLY 2 UNITS COMBINED INTO ONE IN THE ESP ECOCENT AND YOU MUST BE SURE TO UNDERSTAND BOTH ELEMENTS – THE INDIRECT HOT WATER CYLINDER AND THE AIR SOURCE HEAT PUMP. PLEASE ALSO NOTE THAT THE ECOCENT CAN BE INSTALLED IN EITHER A VENTED OR UNVENTED SYSTEM.

3.0 COMPONENT CHECK LIST



Before commencing installation of the unit, check that all the components for your unit are contained in the package. The following components are supplied as standard with all Ecocents to be installed in a “mains pressure” configuration:

- Factory fitted immersion heater (s) and thermal controls.
- Cold Water Combination Valve (comprises Pressure Reducing Valve, Stainer and

Check Valve).
Expansion Core Unit (comprises Check Valve and Expansion Valve).
Temperature/Pressure Relief Valve (set at 90 - 95°C/1 Mpa (7bar)).
Tundish (included in Cold Water Combination Valve pack).
Factory fitted Indirect Thermostat and Thermal Cut-out.

4.0 SITING THE UNIT



The unit must be vertically floor mounted. It can be placed anywhere convenient provided that the discharge pipe(s) from Safety valves and air handling duct work can be correctly installed. Areas that are subject to freezing must be avoided. Ensure that the floor is of sufficient strength to support the the weight of the unit when it is full of water. Pipe run lengths should be kept as short as possible for maximum economy and efficiency : the use of secondary returns should be avoided.

Access to controls, immersion heaters and indirect controls must be maintained for servicing and maintenance of the unit. Please do not install valves or pipe work (except discharge pipe) within 50mm (2") of the T&P relief valve to allow insulation to be fitted.

Consideration must be given to the use of insulated ducting to carry air to and from the unit. Insulated ducting *must* used where condensate may form on the duct work.



IMPORTANT NOTE: DO NOT SITE THE UNIT IN THE SAME ROOM AS AN OPEN FLUED APPLIANCE OR IN A ROOM FROM WHICH AN OPEN FLUED APPLIANCE TAKES ITS COMBUSTION AIR, UNLESS THE MATTER HAS BEEN CAREFULLY CONSIDERED AND ADEQUATE DUCTING AND VENTILLATION HAS BEEN PROVIDED FOR THE ECOCENT AND THAT THE OPEN FLUED APPLIANCE AIR SUPPLY NEEDS HAVE BEEN CALCULATED BY AN APPROPRIATELY QUALIFIED SPECIALIST.



Please be sure to use appropriate lifting equipment when moving the unit.

Some things to be considered in positioning the unit:

Waste heat is useful heat (picture 1)

The Ecocent can receive ducted waste heat from another area in the building – duct work can be fixed to the top of the unit and may be up to 8m long. Areas over 8m away can be used if an additional in-line fan is fitted in the ductwork. The Ecocent can also draw heat from the room in which it is sited.

Always be sure to site the unit and arrange the duct work to allow for adequate heat availability. This will allow the Ecocent to operate efficiently (the inlet air should not be below 8° C).

The optional secondary coil in the Ecocent enables direct connection to a second stable heat source, e.g. a solar heating system or a boiler.



Under no circumstances is the Ecocent to be installed onto an uncontrolled heat source e.g wood burner or back boiler



Picture 1

Dehumidification – The Ecocent can be used to dehumidify rooms that are hot and damp – e.g. Laundry Rooms (See Picture 2). The unit is equipped with a condensate drain that must be properly directed to a suitable waste pipe where the condensate water (non acidic) can drain away. If the drain is into a main sewer it must have a trap installed to prevent back smell through the Ecocent.



Picture 2

Cooling in the re-circulating air mode (picture 3)

The Ecocent can extract warm air and place cooled, dehumidified, outlet air back into the same room – this is perfect for cellars and gymnasiums. Any cold air exhaust air ducting must be lagged when passing through a warmer area to prevent the formation of condensate. All ducting should be 150mm or split into two ducts of not less than 108mm diameter.

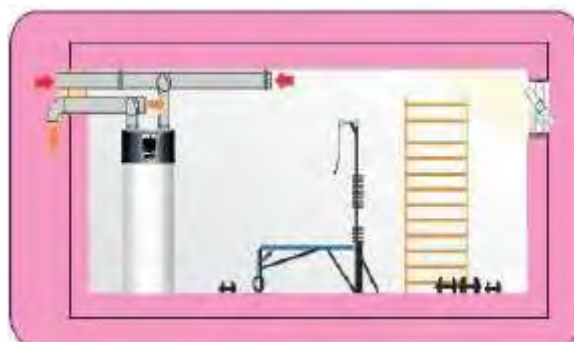

Picture 3

Directional cooling ducting (picture 4) can be fitted with air diverters (e.g. the ESP “Ecobox”) so that the cool exhaust air can be directed to chosen areas.



Picture 4

Siting the Ecocent – some points:

1. Decide upon the right route to be taken to move the unit to the chosen position.
2. Where possible, move the Ecocent to its final location in its original case to avoid damage.
3. The unit and electrical connections must be installed by suitably qualified and experienced technicians.
4. Ensure that no building materials or debris are allowed to enter the air ducts at the top of the unit or any extension of the ducts.
5. The surface on which the Ecocent is placed must be capable of supporting the weight of the *filled* unit and must be flat ($\leq 2^\circ$ from horizontal.)

4.1 Some Notes on Ducting.

Air ducts to and from the heat pump should be 150mm pipe or split into two ducts of not less than 108mm diameter.

The outlets should be fitted with a suitable gravity vent to prevent rain, debris, animals and plants entering the ducts.

You can use rigid or flexible ducting. It is always best to use insulated ducting so that condensation is avoided.

When servicing the unit, ducting should be checked to make sure that it is clear and all obstructions must be removed.

4.2 Water Supply

Because water composition can vary greatly, it is not ESP's policy to issue recommendations relating to water treatment. The user or the owner is responsible for contacting a specialized water treatment company to obtain water treatment advice appropriate to your location. Appropriate water treatment processes/devices must be fitted to ensure the longevity of the unit and its proper operation.

Bear in mind that the mains water supply to the property will be supplying both the hot and cold water requirements simultaneously. Therefore, it is important that the maximum water demand be assessed and the water supply checked to ensure that it can meet peak demand.

NOTE: A high mains water pressure will not always guarantee high flow rates. The main supply pipe to the unit must be 22mm. The minimum mains water supply requirements should be 0.15 MPa (1.5 bar) working pressure and 20 litres per minute flow rate *at the Ecocent*. At these levels, outlet flow rates may be poor if several outlets are used simultaneously – the higher the available pressure and flow-rate the better the system performance will be.

The unit has a design operating pressure of 3 bar which is controlled by the Cold Water Combination Valve on the cold water feed pipework. The Cold Water Combination Valve can be

connected to a maximum mains supply pressure of 1.5 MPa (15 bar). The water supply must be of wholesome water quality (Fluid Category 1 as defined by the Water Supply Regulations 1999). The unit **MUST** be level (see above), otherwise this could cause problems with condensate draining from the heat pump section of the unit in to the condensate drain.



An inline strainer (if open vented) and scale inhibitor (WRAS approved) must be fitted “in line” on the water supply to the unit. Failure to fit these will invalidate the unit warranty/guarantee. All fittings must be WRAS approved.

If installing the unit in unvented configuration, an “unvented Pack”, containing the required safety valves must be supplied with the unit and there is likely to be an additional cost for this.

4.3 Outlet/Terminal Fittings (taps etc.).

The unit can be used in conjunction with most types of terminal fittings. It is helpful in many mixer showers to have balanced hot and cold water supplies; in these instances the balanced cold water supply can be taken from the tapping on the combination valve. Branches to cold drinking water outlets should be taken before the combination valve.

NOTE: Accessories should have a rated operating pressure of at least 0.8 MPa (8 bar).

4.4 Limitations



The unit should not be used in any of the following instances:

With a water supply from solid fuel boilers or any other boiler in which the energy input is not under effective thermostatic control, unless additional, necessary and appropriate safety measures are installed.

With gravity circulation primaries unless a good head of pressure is available.

With steam heating plant unless additional and appropriate safety devices are installed.

With ascending spray type bidets or any other facility where there is a Class 5 back siphoning risk requiring that an appropriate air gap be employed.

With water supplies that have either inadequate pressure or where the supply may be intermittent.

In situations where it is not possible to pipe away any discharge from the safety valves safely.

In areas where the water contains a high proportion of solids, e.g. suspended matter that could block the strainer, unless adequate filtration can be ensured.

Where another appliance in the room is vented by way of an open flu.



The installation must be carried out in accordance with the relevant requirements of:

- A) The appropriate Building Regulations: either The Building Regulation (England and Wales), The Building Regulations (Scotland) or Building Regulations (Northern Ireland).
- B) The Water Fittings Regulations (England and Wales) or Water Bye laws (Scotland).
- C) EN 806.
- D) Any other applicable Regulations.

Failure to observe any of the above conditions will invalidate the warranty/guarantee.

4.5 Hot Water Heat Air Source Heat Pump Package.

Where the unit is to be installed as an unvented system it will be supplied with the fittings needed to allow installation to comply with G3 Regulations – This means that the supply cost for the unvented configuration unit will be higher than when installed as a vented system as additional fittings are required. Where the unit is to be installed in a vented system, such fittings will not be necessary.

4.6 Basic System Schematic

The following is a basic layout of a Ecocent system:

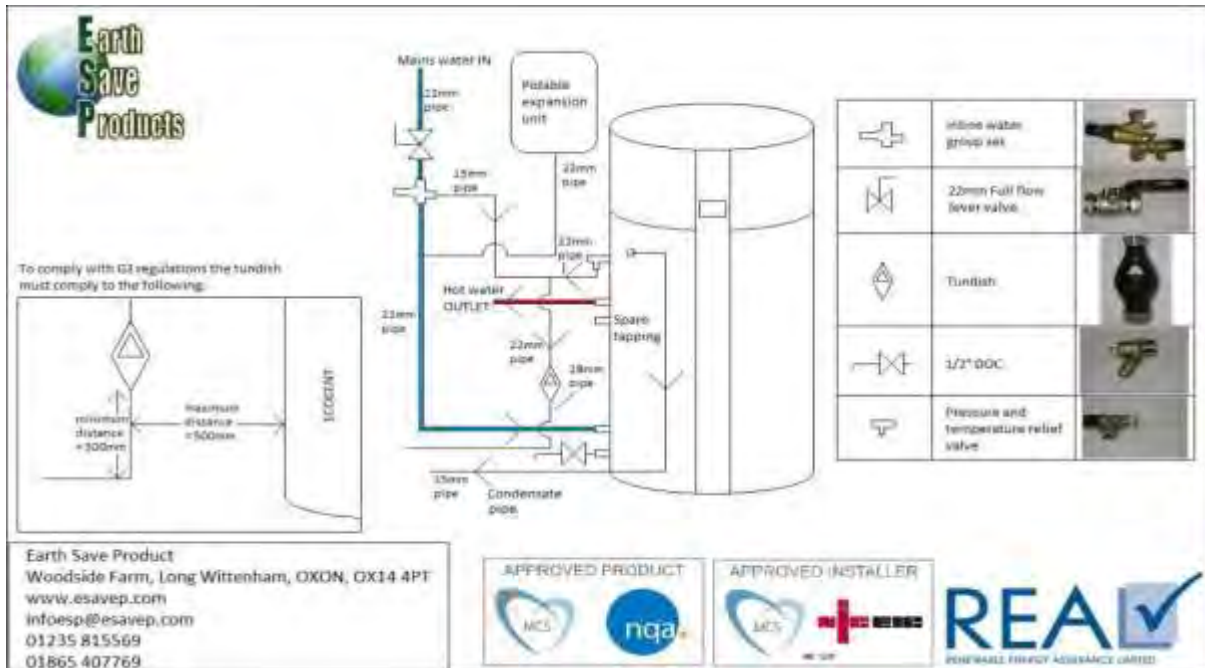

5.0 SPECIFICATION

5.1 Appearance

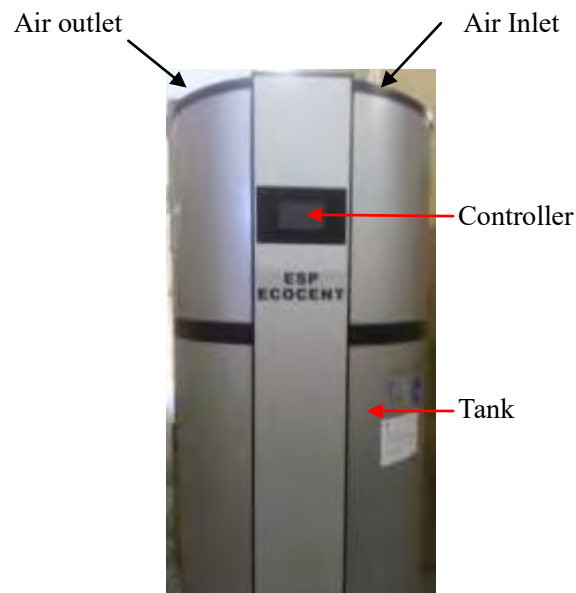

Good Looking and Efficient

The attractive design allows the unit to be placed in the open in finished utility spaces and basements; depending on ambient conditions, the cost of operation can be up to 75% less of that of an electric water heater, and can be used in conjunction with solar hot water heating.

Environmentally friendly and safer

The unit produces no harmful emissions locally; there is no combustion of oil, coal, or natural gas. No carbon monoxide is produced and there is no open flame.

Easy to operate and multiple heat sources

Although the Ecocent Maxi will run most efficiently if allowed to run continuously, it is equipped with a timer for automatic start-up and stop and an adjustment for the easy setting of water temperature. The unit can take heat from a number of sources in domestic installations, or from hot areas in light industrial environments.

5.2

Dimensions

Dimension	(mm)
A	1945
B	1140
C	860
D	640

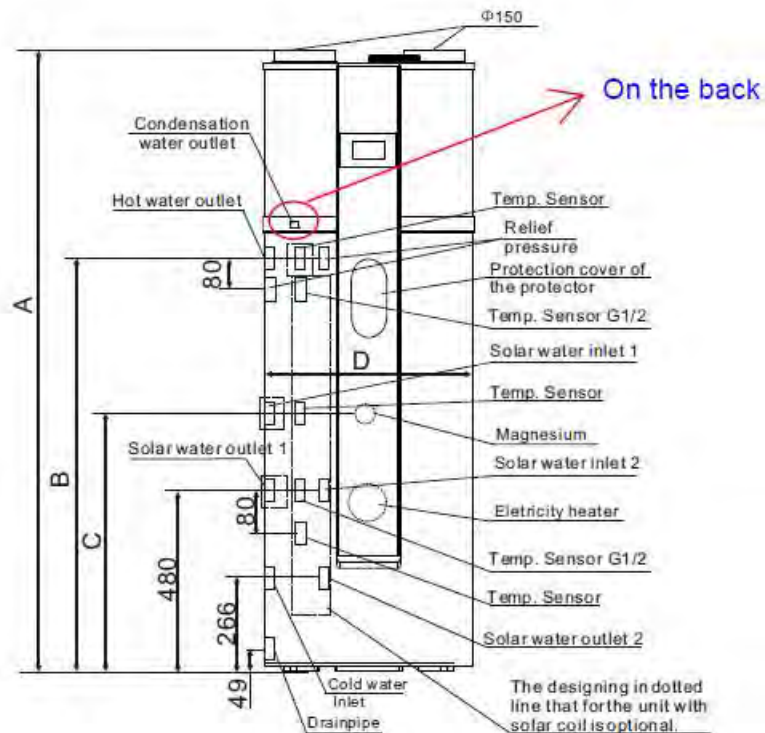

PLEASE NOTE: The Ecocent is available with 0 or 2 Secondary Coils as optional extras. Please contact your seller, installer or ESP if you wish to discuss which configuration best suits your requirements.

5.3 Specifications

Specification	Units	Value
Heating Capacity	kW	3.45
WATER Tank Capacity	L	300
Power Input	kW	.89
Running Current	A	4.0
Power Supply	V/Hz	230V/50Hz
Number of Compressors	Units	1
Compressor Type	Type	Rotary
Rated Outlet Water Temperature	°C	55
Air Volume	m ³ /hr	350
Air Pressure	Pa	40
Duct Diameter	mm	Ø150
Noise	dB(A)	45
Water Inlet/Outlet Size	inch	¾
Immersion Heater	kW	1.5
Net Dimensions	mm	See Section 5.3
Shipping Weight	mm	See Shipping Label
Specification	Units	Value
Net Weight	Kg	See unit Label
Shipping Weight	Kg	See Shipping Label

Note: Test Conditions:

Ambient temperature : 15°C/13°C Water inlet 15°C, Water Outlet 45°C

Working conditions: 0-43°C

Maximum water temperature storage: 60°C

Water temperature range: 9-60°C

Water pressure operating range .15-.07MPa

Running current quoted is without the Immersion Heater.

5.4 PERFORMANCE

5.4.1 Performance Assumptions

Heating Capacity

The unit absorbs energy from the air taken in through the inlet ductwork. If the air inlet temperature is low, heating capacity will show a variation from standard conditions.

3 Minutes Protection

When the unit stops, if you try to restart the unit (or turn the unit on manually) immediately, the unit will not run for 3 minutes. This is built in protection for the compressor.

Heating Mode Operating

If the ambient temperature is very high the fan motor will stop running to protect the unit.

Defrosting

When in heating mode, the unit will defrost automatically, when required. The defrosting process takes 2 to 10 minutes to complete. The fan motor will stop running when the unit is defrosting.

Working Conditions

The unit should be run in ambient temperatures of 0-43 deg. The unit includes sophisticated electronic devices - do not fill the Ecocent with un-treated water from a lake, river water or groundwater and be sure

to put an in-line strainer (open vented) and scale inhibitor in the cold water feed - failure to do so will invalidate the warranty/guarantee.

5.5 DHW Recovery times

The recovery time of your Ecocent (the time it takes to return to fully hot) depends on the storage temperature (normally 55°C), the temperature of your cold water supply (normally taken to be 10°C), the temperature of the air supply (at least 15°C) and the amount of water you use. Typically, a single person uses about 45l of hot water per day. However, it would be unusual to use all this hot water at the same time. A shower uses around 30l and a bath uses around 65l. The recovery times based on proscribed test data (15 °C ambient air and 55°C flow temperature) are as follows:

Volume	Time
10l	7 mins
15l	11 mins
20l	14 mins
30l	21 mins
40l	28 mins
65l	47 mins

But, because the Ecocent unit uses waste heat, the expected recovery times are likely to be much shorter and the following table is indicative of more normal recovery times using 20°C ambient air and still 55°C flow temperature:

Volume	Time
10l	6 mins
15l	9 mins
20l	12 mins
30l	17 mins
40l	23 mins
65l	37 mins

In fact, the recovery times could well be even better than this because the air source will probably warmer than used to calculate the above tables. Your Ecocent unit will have been sized based upon normal DHW use profiles and volumes and, save in exceptional circumstances (e.g. visitors using shower/bath), you should not run out of hot water. Should your usage exceed normal expectation, the immersion heater can be used to provide a boost. In fact, in the unusual event that the target temperature (normally 55°C) is not reached within 200 mins, the immersion heater will automatically provide that boost.

Also to be kept in mind is the fact that you will not be paying for an extractor fan to remove heated air from some of the potential places where the Ecocent draws heat from – so a lower air handling cost because the Ecocent works with a lower system pressure differential and smaller fan than an extractor fan unit does. For example, when the Ecocent is drawing air/heat/moisture from a bathroom, an extractor fan will not be running to expel the heat laden air to outside and the motor on an extractor fan is usually larger than the motor on an Ecocent – so you will effectively be running the Ecocent for nothing and generating DHW using heat that would otherwise be completely wasted.

Whilst this indicates the principles of costs and savings associated with the Ecocent in terms of varying Standards measurement criteria, it also demonstrates is that it is important to consider carefully where you draw air/heat from to generate DHW – savings generated by the Ecocent are almost always significant, but can be maximised through careful design and heat use planning. The supplier/installer of your Ecocent unit should always be prepared to assist you with this.

6.0 INSTALLATION

6.1 Installation Sketch Map (Secondary Coils Optional)

Unless requested, air ducting will not be supplied because we don't know how much you will require for your project.



The P&T valve is a mandatory part of the system. It must not be obstructed, its operation impeded or its configuration or modified in any way. The outlet **MUST** be left unblocked and the drain pipe **MUST** lead to a suitable drain via a tundish. See also section 4.6.

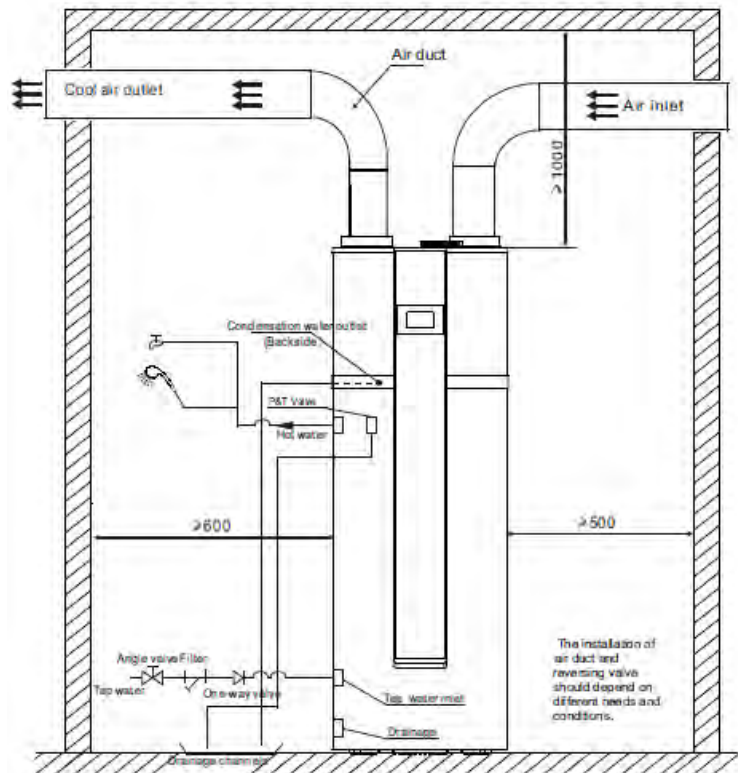

Where the unit is installed to draw in air, or dispose of air, from sites more than 8m from the unit a booster fan must be fitted within the ducting and wired in a manner that the additional fan will run only when the fan within the unit is running.

6.2 Indirect Thermal Cut-Out (Dual Stat) and 2-port Motorised Valve



To comply with Building Regulations and to prevent the unit from overheating, a 2-port motorised valve **MUST** be fitted to the primary flow to the indirect coil(s).

6.3 Pipe Fittings

All pipe connections to the unit are 22mm. The fittings are also threaded 3/4" BSP male.

Air ducts must be at least 150mm in internal diameter. It is recommended that you use insulated ducting on both inlet and outlet ducts.

6.4 Cold Water Supply



The cold water feed should only be from a mains or treated well water supply. Under no circumstances should an untreated well, lake or other source be used.

A 22mm cold water supply is recommended, however, if a 15mm (1/2") supply exists which provides sufficient flow (see section 2.3) this may be used. More flow noise may be experienced from small bore pipes due to the increased water velocity through them. The Cold Water Combination Valve supplied with the unit incorporates a full flow isolating valve which will enable the unit to be isolated from the mains supply for maintenance or servicing. To close the valve the black handle should be turned so that it lies at 90° to the direction of flow. To open turn the handle so that it lies parallel to the direction of flow.

An inline filter (open vented) and an effective scale prevention device must be fitted to the cold feed inline before the feed reaches the unit.

6.5 Cold Water Combination Valve



The Cold Water Combination Valve must be sited close enough to the unit to allow the safety discharge pipe to run in to the tundish, in line with appropriate Regulations. The expansion (safety valve) must not be used for any other purposes.



Under no circumstances is the expansion vessel to be connected to the balanced cold outlet on the combination group valve.

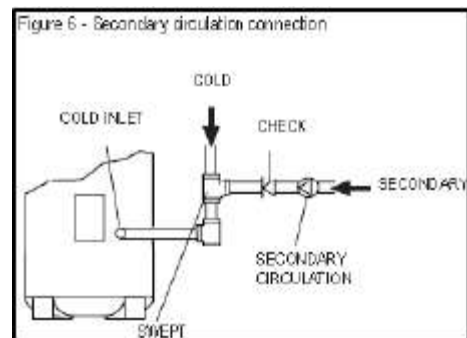

The Cold Water Combination Valve can be installed as a complete one piece unit. The valve incorporates a factory set, non-adjustable Pressure Reducer/ Strainer, an Expansion Valve connection a single Check Valve and balanced cold feed. The valve can be fitted in any orientation to suit the installation, however, ensure that the valve is installed with the direction of flow arrows (stamped on the side of the brass body) pointing towards the unit (in the direction of the flow of water).



If a balanced pressure cold water supply is required for a thermostatic shower mixer valve this must be supplied from the cold water balance outlet (see above). Branches to drinking water outlets should be taken before the combination group valve to avoid the possibility of warm expanded water being drawn from the tap.

Cold Water Balance Outlet



6.6 Drain-Cock

The unit is fitted with a drain-cock and this is used for draining down the unit. You must ensure that this is accessible and that a hosepipe can be easily attached to allow water from the unit to be drained down.

6.7 Outlet Pipe Work

Ideally, the pipe work from the unit's outlet fittings should be in 22mm pipe with short runs of 15mm pipe to showers and basin taps. Small bore pipe can also be used to suit some taps, but runs should be of minimum length. Pipe sizes may vary due to system particulars.

6.8 Secondary Circulation of Hot Water

If a secondary circulation system is required, it should be installed as per Figure 6. The secondary return pipe should be in 15mm pipe and incorporate a check valve to prevent backflow. A suitable WRAS approved bronze circulation pump will be required with appropriate unions. On large systems, due to the

increase in system water content, it may be necessary to fit additional expansion volume to the system by fitting an external expansion vessel to the secondary circuit. This should be done if the capacity of the secondary circuit exceeds 10 litres.

Pipe capacities (copper):

15mm o/d = 0.13 litres per metre run (10 litres = 77m)

22mm o/d = 0.38 litres per metre run (10 litres = 26m)

28mm o/d = 0.55 litres per metre run (10 litres = 18m)

Secondary circulation is NOT recommended for units being used on “Off Peak” electricity tariffs.

Whilst secondary returns do make for greater comfort by having hot water immediately available at taps, it is an energy sapping facility – it is recommended that all secondary returns should be fitted with timers so that circulation is not constant. PLEASE NOTE: All secondary return pipework MUST be very well insulated and, even then, may have a very detrimental impact upon the economics of generating hot water.

6.9 Temperature and Pressure Relief Valve (“TPRV”)

 The TPRV is factory fitted and must not be interfered with in any way and/or removed - under NO circumstances should the installer or end user tamper with the TPRV or the warranty/guarantee for the unit will be invalidated and serious damage may result. If the TPRV fails it should only be replaced by a qualified installer under the following regulations - G3 (ENGLAND AND WALES), TECHNICAL STANDARD P3 (SCOTLAND) OR BUILDING REGULATION P5 (NORTHERN IRELAND) AND THE WATER FITTING REGULATIONS (ENGLAND AND WALES) OR WATER BYELAWS (SCOTLAND)



6.10 Warnings



Under no circumstances should the factory fitted TPRV be removed other than by approved, fully trained and experienced fitters. ***To do so will invalidate any warranty/guarantee or claim and could be dangerous.***



The Cold Water Combination Valve, in-line strainer and scale inhibiting device must be fitted to the cold water supply to the unit.



None of the control or safety valves should be modified in any way nor their operation impeded.



Water may drip from the discharge pipe of the TPRV and this pipe must be left open to the atmosphere. The discharge pipe should not be blocked or used for any other purpose.



For units with secondary coil facilities, please discuss the use of the coil, and a suitable configuration for use, with a suitably qualified plumber/engineer before proceeding to add a heat source to the secondary coil.

6.11 Discharge Pipe Work

It is a requirement of Building Regulations that any discharge from an unvented system is conveyed to a position where it is visible, but will not cause danger to persons in or about the building. The tundish and discharge pipes should be fitted in accordance with the requirements and guidance notes of Building Regulations Information Sheet No. 33, available from the British Board of Agreement gives further advice on discharge pipe installation. For discharge pipe arrangements not covered by G3 Guidance or BBA Info Sheet No.33, advice should be sought from your local Building Control Officer. Any discharge pipe connected to the pressure relief devices (Expansion Valve and Temperature/ Pressure Relief Valve) must be installed in metal, in a continuously downward direction and in a frost free environment. The water may drip from the discharge pipe of the pressure relief device this pipe must be left open to the atmosphere. The pressure relief device is to be operated regularly to remove lime deposits and to verify that it is not blocked.

Please see figure 7 for typical discharge arrangement.

6.12 Expansion Vessel

An appropriately sized expansion vessel must be fitted to the system in which the unit is incorporated. The Expansion vessel can be fitted to the cold feed in to the unit (see Figures 4 and 6 above).

6.13 G3 Requirement



G3 (ENGLAND AND WALES), TECHNICAL STANDARD P3 (SCOTLAND) OR BUILDING REGULATION P5 (NORTHERN IRELAND) AND THE WATER FITTING REGULATIONS (ENGLAND AND WALES) OR WATER BYELAWS (SCOTLAND) state that here shall be precautions to ensure that the hot water discharged from safety devices is safely conveyed to where it is visible but will not cause danger to persons in or about the building.

6.14 G3 Guidance Section



The installation should include the discharge pipe(s) (D1) from the safety device(s). In either case the tundish should be vertical, located in the same space as the unvented hot water storage system and be fitted as close as possible and within 500mm of the safety device(s) e.g. the TPRV. The discharge pipe (D2) from the tundish should terminate in a safe place where there is no risk to persons in the vicinity of the discharge, be of metal and:

- a) be at least one pipe size larger than the nominal outlet size of the safety device unless its total equivalent hydraulic resistance exceeds that of a straight pipe 9m long i.e. discharge pipes between 9m and 18m equivalent resistance length should be at least two sizes larger than the nominal outlet size of the safety device, between 18 and 27m at least 3 sizes larger, and so on.

Bends must be taken into account in calculating the flow resistance. Refer to figure 7 and Table 1 below. An alternative approach for sizing discharge pipes would be to follow BS6700:1987 Specification for design, installation, testing and maintenance of services supplying water for domestic use within buildings and their curtilages, Appendix E, section E2 and table 21.

b) have a vertical section of pipe at least 300mm long below the tundish before any elbows or bends in the pipe work.

c) be installed with a continuous fall, and in a frost free environment.

d) have discharges visible at both the tundish and the final point of discharge, but where this is not possible or is practically difficult there should be clear visibility at one or other of these locations.

Examples of acceptable discharge arrangements are:

i. ideally below a fixed grating and above the water seal in a trapped gully.

ii. downward discharges at low level; i.e. up to 100mm above external surfaces such as car parks, hard standings, grassed areas etc. are acceptable providing that where children may play or otherwise come into contact with discharges a wire cage or similar guard is positioned to prevent contact, whilst maintaining visibility.

iii. discharges at high level; e.g. into a metal hopper and metal down pipe with the end of the discharge pipe clearly visible (tundish visible or not) or onto a roof capable of withstanding high temperature discharges of water and 3m from any plastic guttering system that would collect such discharges (tundish visible).

iv. where a single pipe serves a number of discharges, such as in blocks of flats, the number served should be limited to not more than 6 systems so that any installation discharging can be traced reasonably easily. The single common discharge pipe should be at least one pipe size larger than the largest individual discharge pipe (D2) to be connected. If unvented hot water storage systems are installed where discharges from safety devices may not be apparent i.e. in dwellings occupied by blind, infirm or disabled people, consideration should be given to the installation of an electronically operated device to warn when discharge takes place.



Note: The discharge will consist of very high temperature water and steam. Asphalt, roofing felt and non-metallic rainwater goods may be damaged by such discharges and you must take this in to account when fitting the unit. Should such damage be caused, ESP will accept no liability for any consequent damage so caused.

Table 1 - Sizing of copper discharge pipe (D2) for common T&P relief valve sizes.

WATER VULVE SIZE	MINIMUM SIZE OF DISCHARGE PIPE D1	MINIMUM SIZE OF DISCHARGE PIPE D2 FROM TUNDRISH	MINIMUM RISERANCE ALLOWED, EXPRESSED AS A LENGTH OF STRAIGHT PIPE (E.G. NO. ELBOWS OR BENDS)	RESISTANCE CREATED BY EACH ELBOW OR BEND
G 1/2	15MM	22mm 28mm 35mm	UP TO 5M UP TO 15M UP TO 21M	0.8M 1.0M 1.6M
G 3/4	22MM	28mm 35mm 42mm	UP TO 5M UP TO 15M UP TO 21M	1.0M 1.4M 1.7M
G 1	28MM	35mm 42mm 50mm	UP TO 5M UP TO 15M UP TO 21M	1.4M 1.7M 2.3M

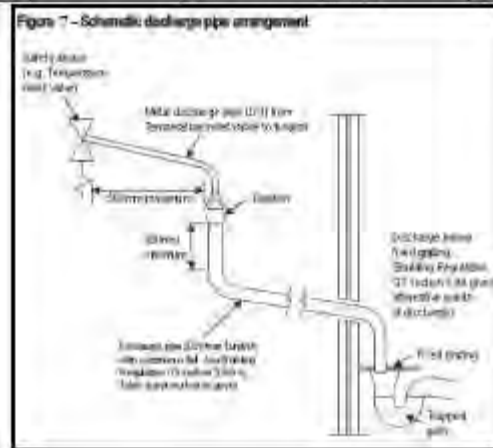

7.0 HOW TO CONNECT TO THE HEAT PUMP

As the heat pump is an integral part of the unit, there are no special requirements for attaching the heat pump to the integrated cylinder – all mechanical and electrical connections are factory made.

PLEASE NOTE that only manufacturer approved engineers should carry out any work on the heat pump. Call the manufacturer for the name of an approved engineer in your area.

7.1 Insulation treatment



As per the below picture, you must insulate all connecting pipes and you must use high quality, non flammable, PVC insulating material, of 15mm-20mm thickness.

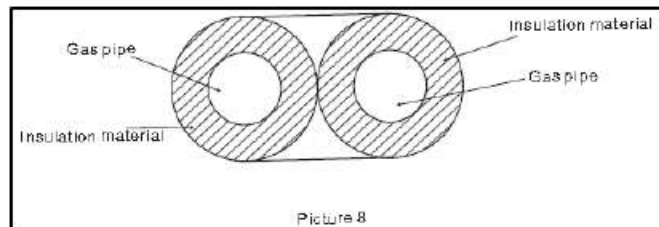

A) To keep the pipes in a tidy state, you may wrap the pipes together after being separately insulated.

B) Under no circumstances should you let electric wires come into contact with the plumbing.

7.2 Wiring



All electrical wiring MUST be carried out by a competent electrician and be in accordance with the latest I.E.E. Wiring Regulations. The wiring block diagram is set out below.

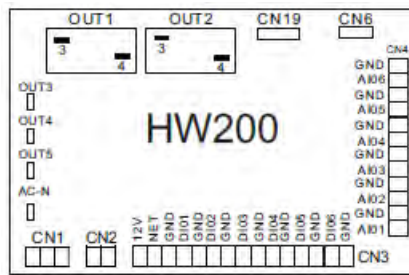

No	Symbol	Definition
1	OUT 1	Compressor (output) (220-230VAC)
2	OUT 2	Heater (output) (220-230VAC)
3	OUT 3	Four way valve (output) (220-230VAC)
4	OUT 4	High speed fan/Source pump (output) (220-230VAC)
5	OUT 5	Low speed fan/Circulation pump/solar pump/recovery pump/Cooling (output) (220-230VAC)
6	AC-N	Ground
7	NET GND 12V	Remote Controller
8	D101 GND	Remote on/off
9	D102 GND	Overheat Protection
10	D103 GND	Low pressure protection
11	D104 GND	High pressure protection
12	D105 GND	(SPARE)
13	D106 GND	Flow switch protection
14	A101 GND	Ambient temperature sensor (input)
15	A102 GND	Bottom of tank temperature sensor
16	A103 GND	Top of tank temperature sensor
17	A104 GND	Coil temperature sensor/antifreeze sensor (input)
18	A105 GND	Suction temperature sensor (input)
19	A106 GND	Solar temperature sensor (input)
20	CN6	Running indication/circulation pump/solar pump

7.3 Earthing



The unit MUST be earthed and a facility is provided for this in the unit design. You must have the unit fitted by a suitably qualified installer – ESP accepts no responsibility for units that are not fitted by fully qualified engineers. Further, failure to have the unit fitted by a suitably qualified installer will invalidate the warranty/guarantee of the unit and may be dangerous.

7.4 Unit and System Controls

The main control that is supplied with the unit is for viewing and altering system operating parameters. Other controls will be necessary to control zone valves for solar or other auxiliary requirements.

7.5 Immersion Heater

The unit is supplied with a 1.5kW immersion heater as standard. This can be used as an alternative and/or complementary heat source (see below) and is used to raise the temperature of the stored water to a temperature above 60°C once a week (automatically) to remove any risk from Legionella bacteria in accordance with EN 806. The immersion heater is located behind the black panel on the front of the unit.

8.0 OPERATION

8.1 Explanation of the Control Panel

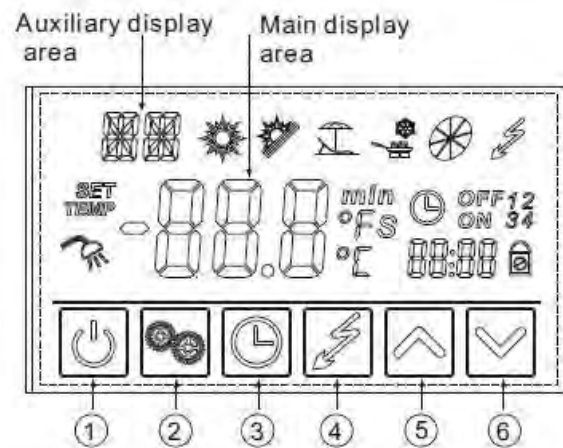

No.	Symbol	Name	Function
①		On/Off key	Used to turn the EcoCent on or off.
②		Mode	Used to switch modes and save parameter settings.
③		Clock	Used to set the timer and turn the timer on or off.
④		Immersion Heater	Used to turn the immersion heater on or off. Press and <i>hold</i> this button to turn the ventilation mode off or on.
⑤		Up	Used to move through the menu or increase the value of a parameter.
⑥		Down	Used to move through the menu or decrease the value of a parameter.

8.2 Display Explanation

Symbol	Meaning	Function
	Heating Mode	Shows that the EcoCent is in heating mode.
	Eco Mode	Shows that the EcoCent is in Economic mode.
	Vacation Mode	Shows that the EcoCent is in Vacation mode.
	Cooling Mode	Shows that the EcoCent is in Cooling mode.
	Fan	Indicates that the fan is on and the fan speed.
	Immersion Heater	Indicates that the immersion heater is on.
	Running Temperature	This symbol means that the target temperature has been achieved.
	Parameter Setting	Means that the selected parameter may now be set..
	Temperature	When this is showing, the temperature is not adjustable.
	Timer Set	This indicates that the EcoCent will be turned on by the timer automatically.
	Timer Set	This indicates that the EcoCent will be turned off by the timer automatically.

<i>min</i>	Minutes	Shows that the value shown is in minutes.
S	Seconds	Shows that the value shown is in seconds.
°C	Celsius	Shows that the value shown is in degrees centigrade.
°F	Fahrenheit	Shows that the value shown is in degrees Fahrenheit.
	Lock	Shows that the keypad is locked.

PLEASE NOTE: When trying to alter the parameters, if you do not press any key for 5 seconds, it will revert to the previous setting.

8.3 BEFORE RUNNING THE UNIT



- 1) Let the unit rest for 1 hour after it has been moved into position.
- 2) Check that the tank is full of water and has been completely purged of air;
- 3) Check that the unit is correctly wired in to the mains power from a suitable MCB.
- 4) When the water tank is full, press the ON/OFF key (.5 second) to start the unit.
- 5) When you power-on the unit the controller will beep.



8.4 Mode selection

Press  to toggle between the five operating modes: Heating Mode, Economic Mode, Intelligent Mode, Vacation Mode and Standby Mode.

- A) Heating Mode: The unit will heat the water using the compressor and the Immersion heater. It can be used when the ambient source temperature is low or a large amount of hot water is needed.
- B) Economic mode: The water is heated using the heat pump only.
- C) Intelligent Mode: The Ecocent will select the heat pump but will add-in the immersion heater if the ambient temperature drops to a level requiring additional heat. ***This is the recommended mode.***
- D) Vacation mode: You can set the unit to start up several months from the current date. This can be used when you have a vacation, it allows you to set the unit to run at a preset date and time for your return from your holiday. Please remember to set the unit to allow time for the water to heat up for your return.
- E) Standby Mode : The unit has power to it but will not run.

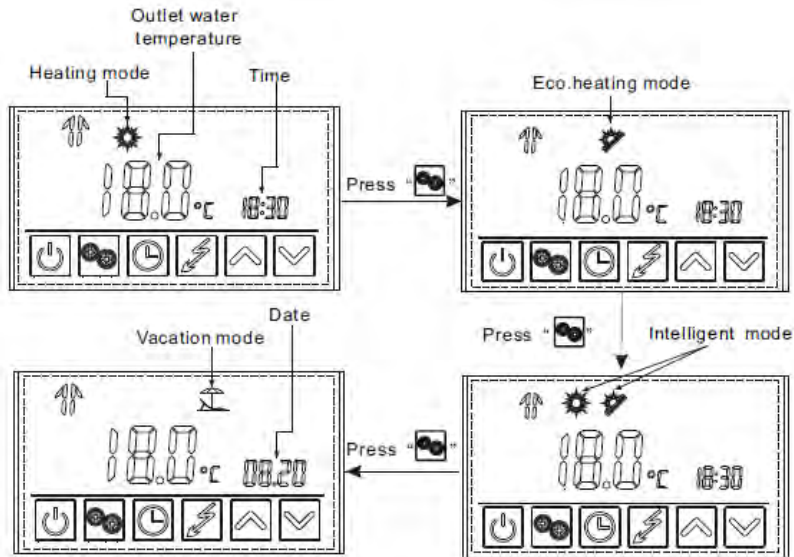



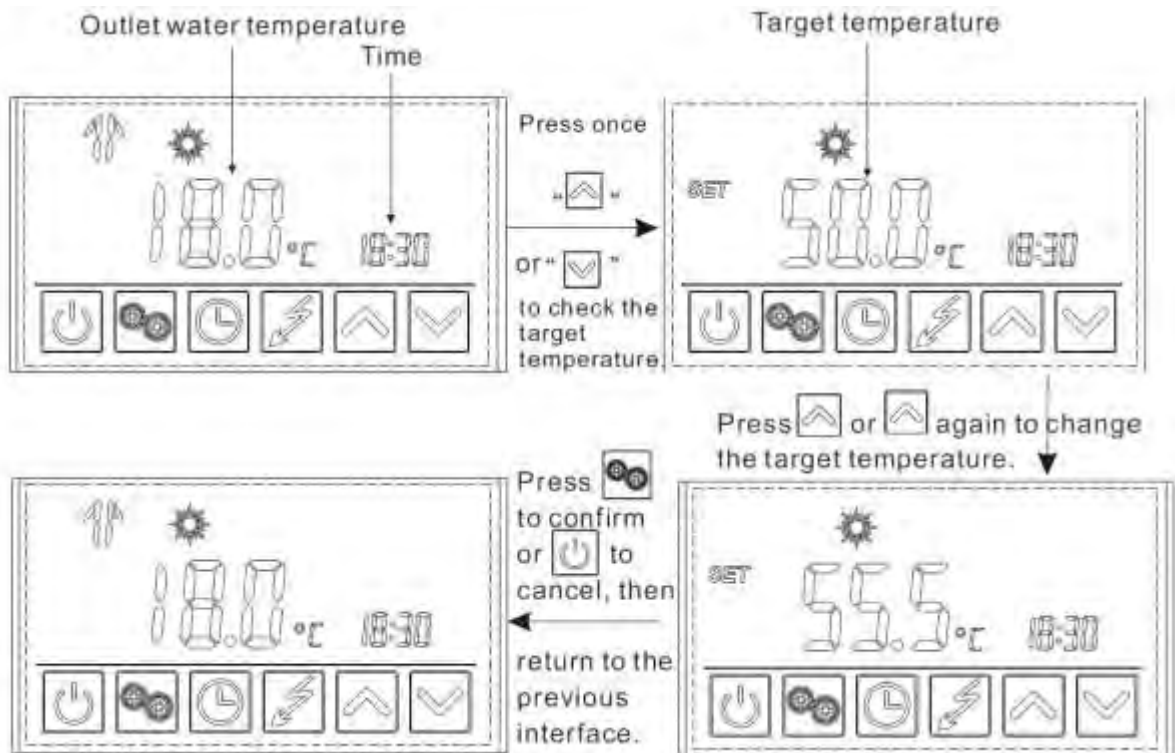

8.5 Setting the Water Temperature

To change the water temperature (the temperature to which the water will be heated and held in the Tank), simply use the up or down buttons to increase or decrease the temperature setting. This can be done in the running or standby modes. Once the required temperature has been set, press the mode key to save the setting or the on/off key to ignore the changes that you have made:



8.6 Setting the Clock.

Press the clock key  and the time will flash. Press the same button again and the hour will flash. Use the  up and/or  down keys to select the correct time then press the  clock key to save the hours setting. The 'minutes' segment will then start to flash. Repeat the above procedure for the minutes, date, month and year settings:

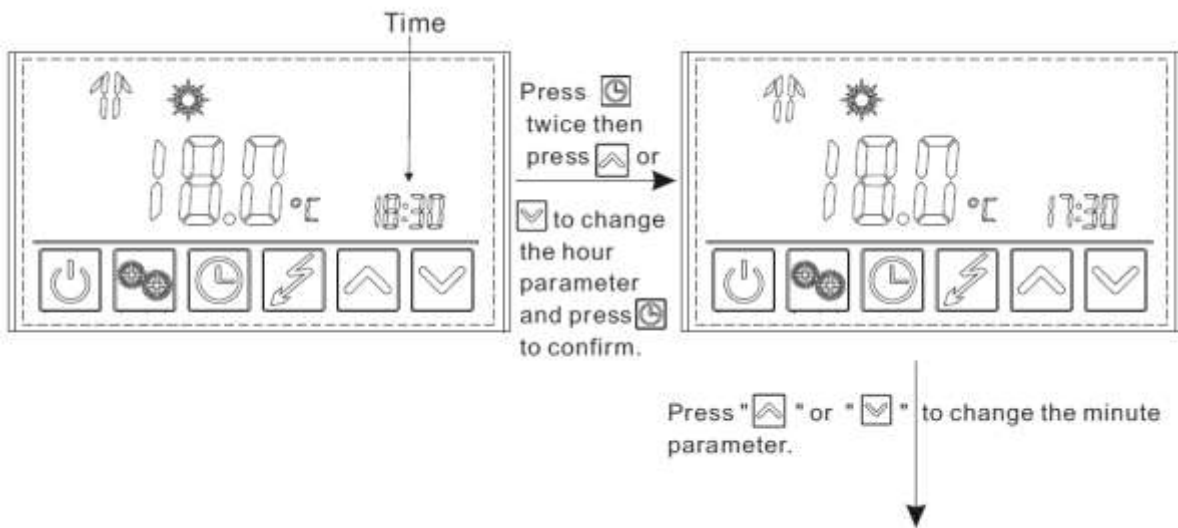

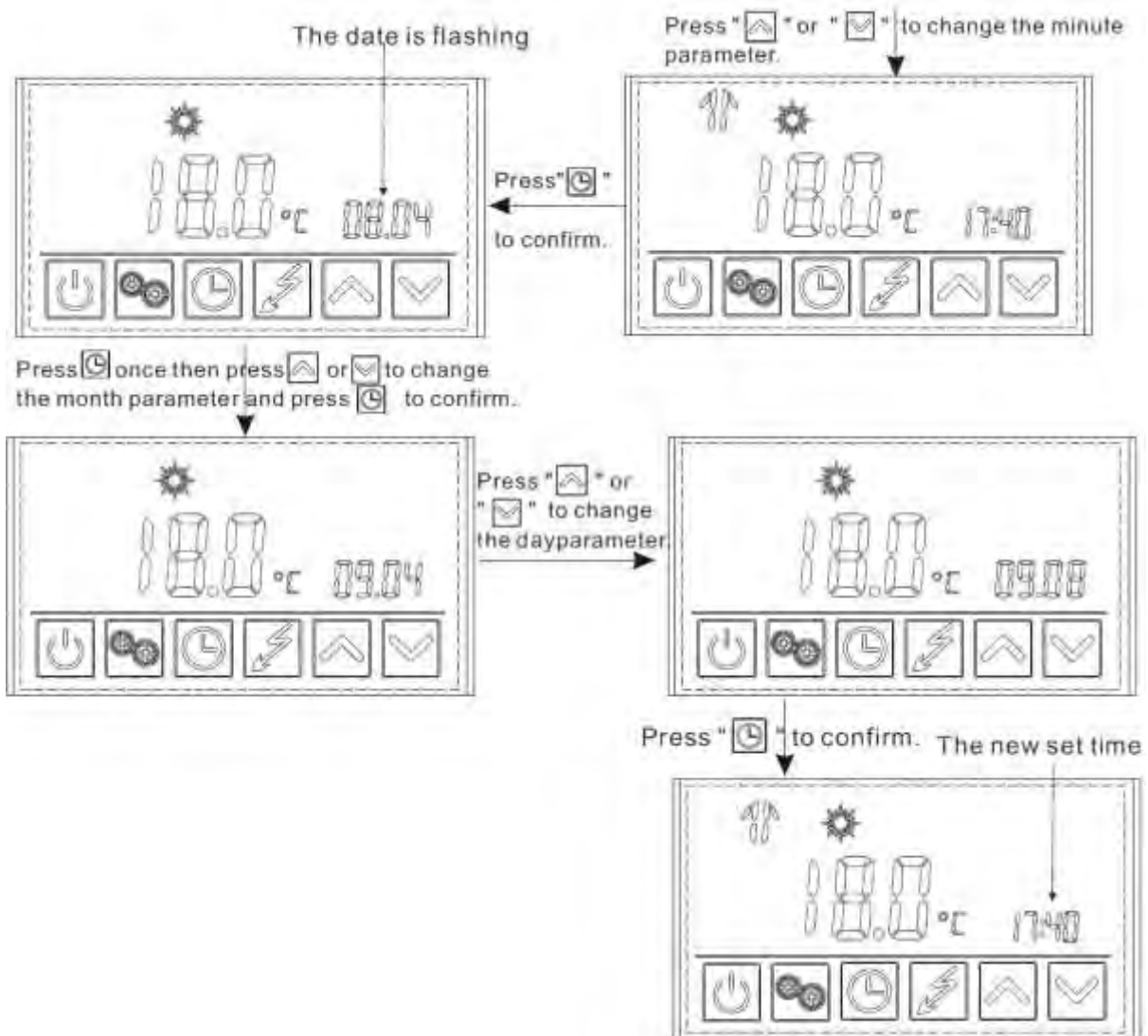



Please note that if no key is pressed for 10 seconds, the display will return to the *Main Interface*.

8.7 Setting the Timer.

Please note that the most economic way of heating your domestic hot water is to leave your Ecocent unit running constantly. Should you elect to use an intermittent heating scheme:

In Heating mode: Press the clock  button and hold for 2 seconds and the symbol "ON 1" will flash.

Pressing  again will allow the hour to be set. Setting the time using the same method as setting the clock then "OFF 1" will flash. Set the off time in the same way as setting the clock. The "ON 2" segment will then flash to allow you to set the second timer period. Once the "ON 2" has been set, the "OFF 2"

will flash and the process repeated. Pressing the  on/off key during the setting process will cancel any changes made:

Heating mode

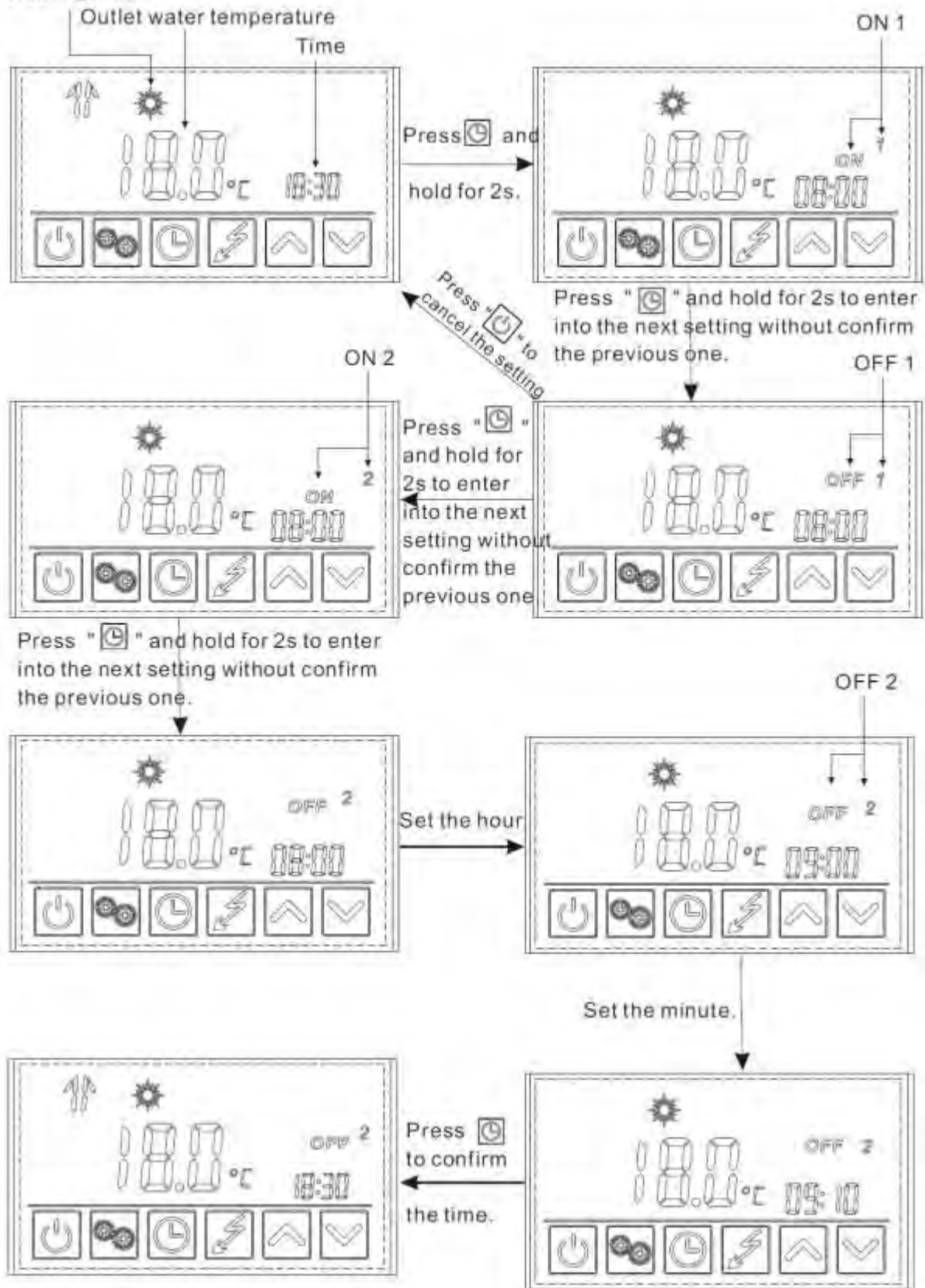

Example: **Running period 1:** 8:00-10:00; **Running period 2:** 16:30-22:00.

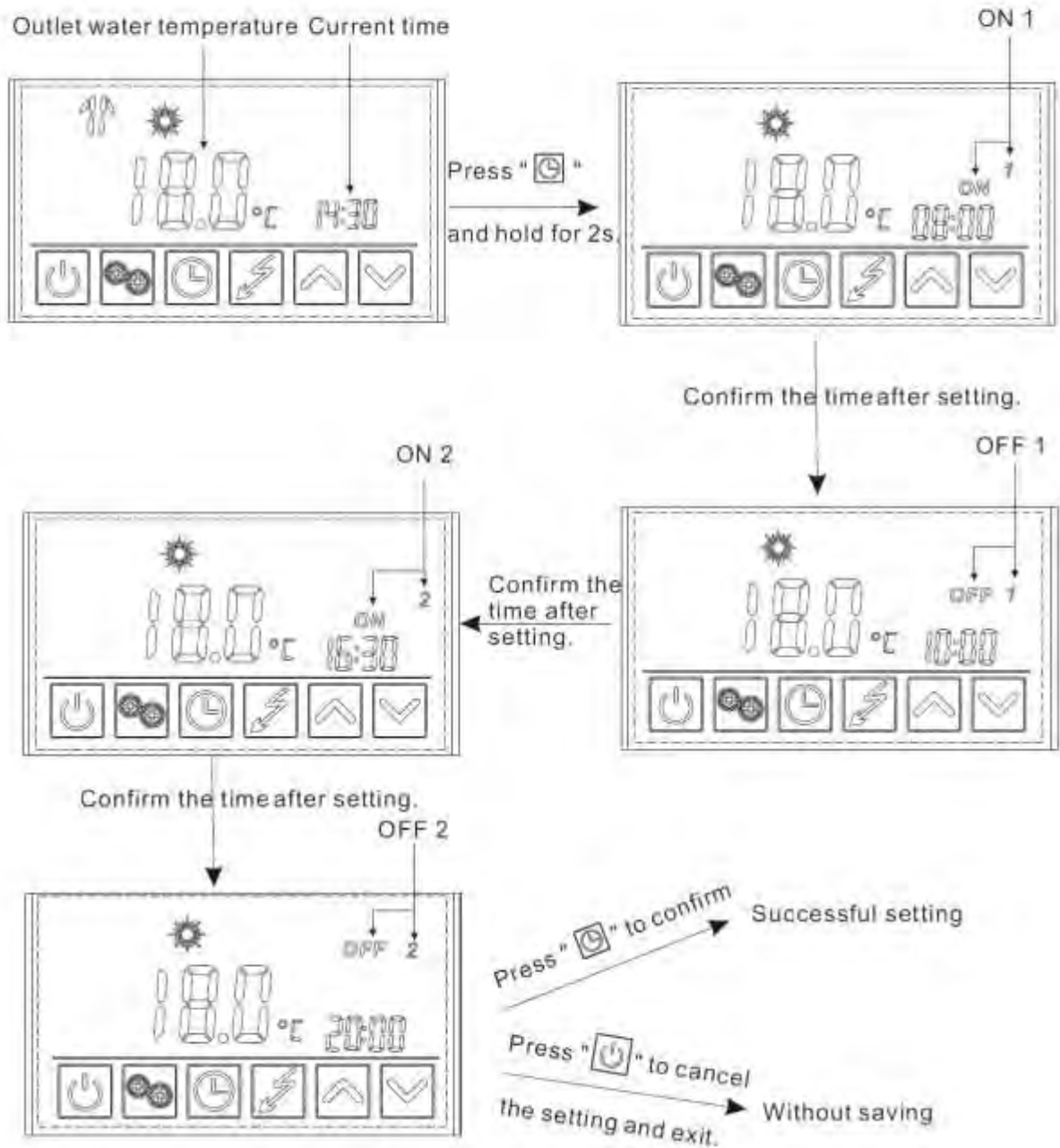

To cancel the timer:

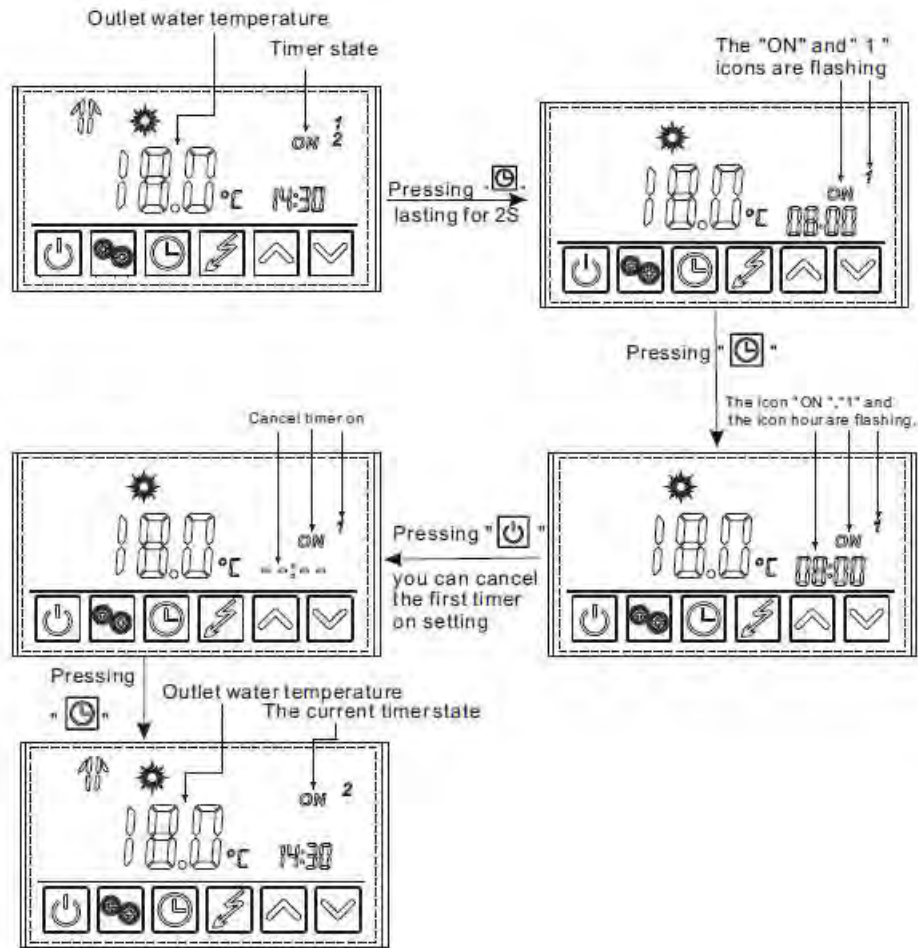

8.8 Setting the Vacation Mode.

Select Vacation mode (see above) then press the 🕒 clock button for 2 seconds. The 'ON' and date symbols will begin to flash. Set the date to a short time before your return from vacation to ensure that you have hot water for your return. Remember to set the unit to standby before leaving for your vacation. The following example sets the Ecocent to re-start on the 28th September:

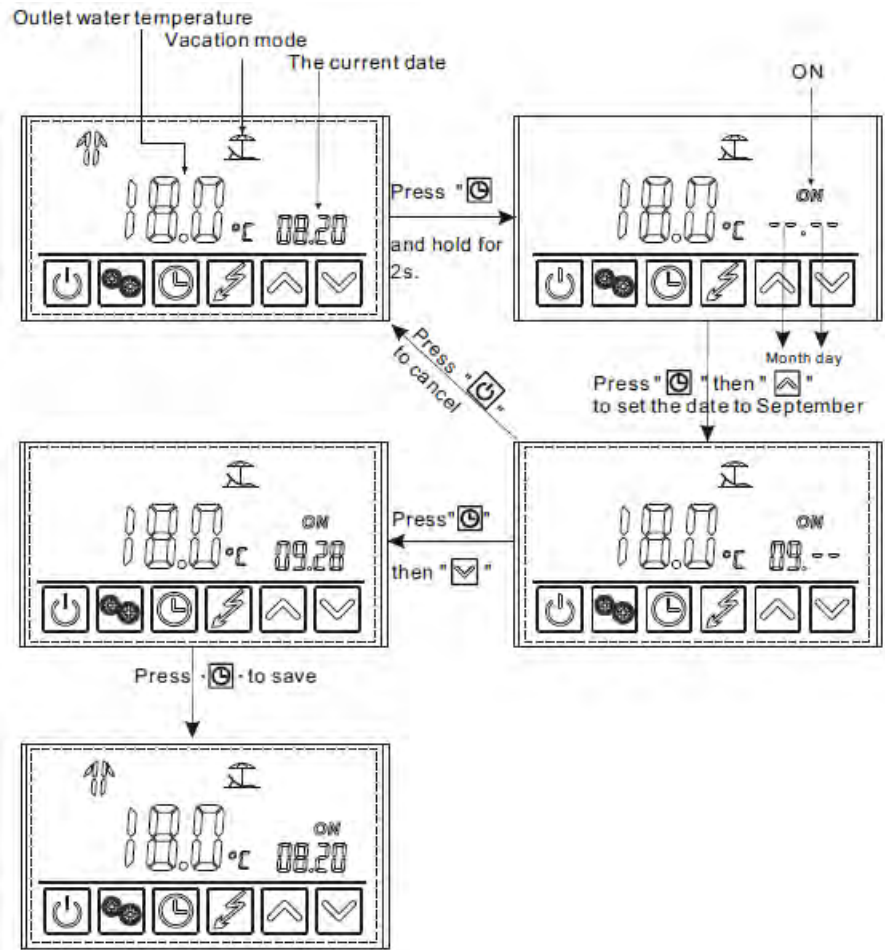

8.9 Using the Immersion heater.

The Immersion heater can be turned on in either heating or standby modes:

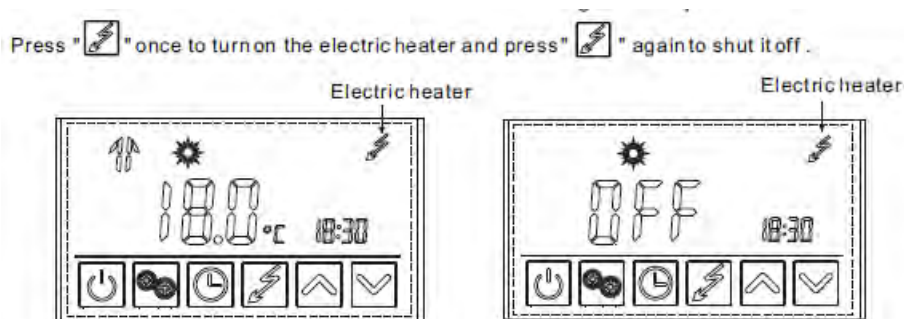



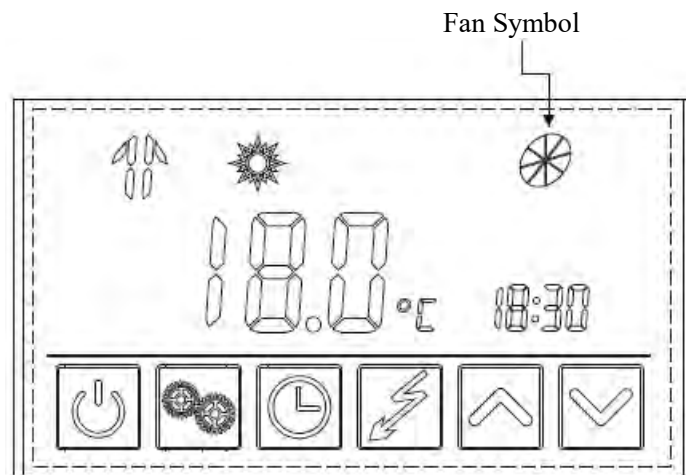

8.10 Setting the fan speed.

The fan can be set to turn off when the target temperature has been reached or run at either slow or high speed. This is achieved by pressing the lightning bolt button. Press this button for 2 seconds and the fan will be set to slow running after target temperature has been reached. Press the lightning bolt button for another 2 seconds and the fan will continue to run at high speed after the target temperature has been reached. Pressing the same

button for a third time (2 seconds again) and the fan will then shut off once the target temperature has been reached:



Fan Symbol Meaning:

-  (Running). This indicates that the fan is running at high speed.
-  (Running). This indicates that the fan is running at slow speed.
-  (Stopped). Indicates that the fan will run at high speed once the target temperature has been reached.
-  (Stopped) Indicates that the fan will run at slow speed once the target temperature has been reached.

Note: if the fan symbol is not displayed, the fan has been switched off.

8.11 Locking the Keypad.

To lock the keypad (strongly suggested), press and hold the  on/off button for 5 seconds. Repeating the process will unlock the keypad:

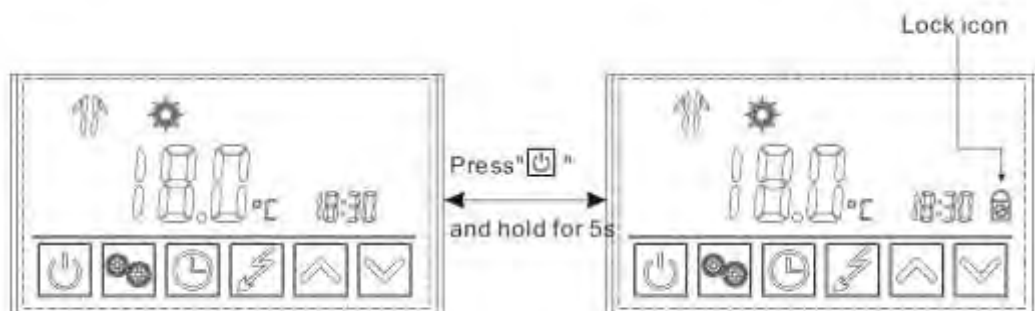

8.11 User Operating Parameters .



The user operating parameter settings for the unit are listed below. You should not need to change any parameter from the default setting and, should you wish to do so, it would be advisable to consult the ESP Technical Team first.

NO.	Meaning	Parameter	Value	Range
1	Start defrost temperature	d01	-3°C	-30~0°C
2	End defrost temperature	d02	13°C	2~30°C
3	Delay time between 2 defrosting cycle	d03	45min	30~90min
4	Max. duration time of defrosting	d04	8min	1~12min
5	Disinfect running time	g02	0min	0~90min
6	The time to start high-temperature disinfection	g03	0h	0~23h
7	The cycle time of high-temperature disinfection	g04	7D	7~99D
8	Electric expansion valve mode	e01	1	0-Manual/1-Auto
9	Expansion valve initiation position	e03	350	0~500
10	The end point of solar water pump	n10	84°C	50~90°C
11	The delay time of electrical heater starting up	r06	200min	0~450min

9.0 MAINTENANCE REQUIREMENTS FOR THE CYLINDER



To ensure the continued optimum performance of the EcoCent, it should be regularly maintained. This is of particular importance in hard water areas or where the water supply contains particulate matter. Maintenance should be carried out by a suitably qualified plumber/engineer and any replacement parts used must only be supplier recommended spare parts. It is recommended that maintenance is carried out every 12 months on the cylinder and includes the checks detailed in this manual. If you are in a hard water area, you should check the magnesium anode deterioration within 6 months of commissioning of the unit and annually 12 months after. You will be able to see the rate at which deterioration is happening and set a date for a full inspection when it is clear that a new magnesium anode is likely to be needed. Keeping a functioning magnesium anode is critical to the longevity of the unit. If you run the unit without the anode you will invalidate the warranty/guarantee and the stainless steel cylinder may be seriously damaged.



In hard water areas consideration should be given to periodically descaling the immersion heater element. To do this the unit will need to be drained; Paragraphs 9.3 to 9.5 below detail how to drain the unit, remove and replace the immersion heater(s).



Please check the condition of the sacrificial magnesium anode on any servicing/maintenance and fit a new anode, if required.

9.1 Checking the operation of the Safety Valves



Slowly open the Temperature and Pressure Relief Valve by twisting its cap for a few seconds. Check water is discharged and that it flows freely through the tundish and discharge pipework. Check valve reseats correctly when released.



Warning : The water discharged may be very hot.

Repeat the procedure for the Expansion Relief Valve (located on the Cold Water Combination Valve or Expansion Valve Core Unit).

9.2 Cleaning the Strainer



The in-line strainer must be cleaned periodically by a suitably qualified engineer. The in-line strainer can be found inside the cold water combination group valve on unvented systems or alternatively a Y strainer on open vented systems.

The engineer should:

- i) Wash any particulate matter from the inline strainer under clean running water.
- ii) Refit the inline strainer once totally clean or install a new one where necessary.

9.3 Draining the Unit

Switch off the electrical supply to the unit. Turn off the mains water supply to the unit. Attach a hosepipe to the drain cock having sufficient length to take water to a suitable discharge point below the level of the unit; at least one metre below the unit is recommended. Open the hot water tap nearest to the unit to relieve the system pressure. Open the drain cock. If water fails to drain from the unit, vent it by manually opening the Temperature/ Pressure Relief Valve or “crack a joint” in the unit plumbing to prevent the creation of a vacuum that may prevent effective draining. The Ecocent should be drained if it is to be switched off for any extended period where there is a likelihood of freezing. It *must* be re-filled before re-starting.

9.4 Descaling the Immersion Heater



Drain the unit. Open the cover to the immersion heater housing and disconnect wiring from the immersion heater. Remove the thermostat by carefully pulling outwards from the immersion heater. Unscrew the immersion heater backnut and remove the immersion heater from the unit. Over time, the immersion heater gasket may become stuck to the mating surface. To break the seal insert a round bladed screwdriver into one of the pockets on the immersion heater and gently lever up and down. Carefully remove any scale from the surface of the element. **DO NOT** use a sharp implement as damage to the element surface could be caused. Ensure sealing surfaces are clean and seals are undamaged; if in doubt fit a new gasket.

Replace immersion heater ensuring (where appropriate for the unit being worked upon) the lower (right angled) element hangs vertically downwards towards the base of the unit. It may be helpful to support the immersion heater using a round bladed screwdriver inserted into one of the thermostat pockets whilst the backnut is tightened. Replace the thermostat by carefully plugging the two male spade terminations on the underside of the thermostat head into the corresponding terminations on the element. Rewire the immersion heater. Close and secure terminal cover the refill the unit.

9.5 Refilling the System



DO NOT switch on the immersion heater or heat pump part of the unit until the system has been completely refilled and completely purged of air. Close the drain tap. With the hot tap open, turn on mains water supply. When water flows from the hot tap allow to flow for a short while to purge air and to flush through any disturbed particles. Close the hot tap and then open successive hot taps in system to purge any air. The electrical supply can then be switched on.

9.6 Log Book



Please complete the log book supplied with the Ecocent, stating what has been done, the date of the service and the name/contact details of the servicing engineer.

9.7 Maintenance Requirements

There are no formal annual maintenance requirements. However, it is advisable to check annually:

- a) That the pressure and temperature relief valve is still functioning well by turning the plastic black cap around to make sure that water comes out of the valve when the clack cap is turned.
- b) Filters for debris.
- c) That the air outlet to outside to make sure that it is clear from foliage, nests, etc.
- d) Check and clean the condenser of any obstruction. Care should be taken during this operation as the condenser is very delicate and any damage will impair the efficiency of the Ecocent and may invalidate the warranty.

Please note that the top cover of the Ecocent can be removed by a suitably qualified engineer/plumber so that the evaporator can be cleaned of dust and debris.

10.0 SIMPLE FAULT FINDING

Should your Ecocent unit malfunction, the display will change to indicate the cause of the malfunction. The following table is a list of simple faults and actions that can be taken to clear them. Diagnosis, testing and repair should be carried out by a suitably qualified and experienced engineer/plumber.

Malfunction	Display	Possible Causes	Remedy
Temperature Sensor failure	P01	Bottom temperature sensor failure.	Check or change sensor.
Temperature Sensor failure	P02	Top temperature sensor failure.	Check or change sensor.
Temperature sensor failure.	P04	Ambient temperature sensor failure.	Check or change sensor.
Temperature sensor failure.	P05	Pipe temperature sensor failure.	Check or change sensor.
Temperature sensor failure.	P07	Evaporator temperature sensor failure.	Check or change sensor.
Temperature sensor failure.	P09	Anti-freeze temperature sensor failure.	Check or change sensor.
High pressure protection	E01	Exhaust pressure too high.	Check high pressure switch and coolant return circuit.
Low pressure protection	E02	Suction pressure too low.	Check low pressure switch and coolant return circuit.
Water flow failure	E03	No or too little water in system.	Check the flow volume and water pump.
Immersion heater overheat	E04	Water flow volume too low or system pressure difference too low.	Check the flow volume and water flow.
Antifreeze protection	E07	Water flow volume too low or system pressure difference too low.	Check the flow volume and water flow.
Antifreeze protection 1	E19	Ambient temperature too low.	
Antifreeze protection 2	E29	Ambient temperature too low.	

10.1 FAQs

1. *Why does the compressor not start when I turn the unit on?*

Answer: If the unit has recently been running, the compressor will not start within 3 minutes of shutting down. It will start automatically once this 3 minutes is up.

2. *Why does the outlet temperature rise slowly at times?*

Answer: There is a temperature difference between the top and the bottom of the tank if the unit has either just been started or there has been an unusually large amount of hot water drawn off.

3. *Why does the temperature on the display decrease when the unit is actually heating?*

Answer: As water is drawn off, cold water is let into the bottom of the tank. Due to convection, this will mix with the hot water in the top of the tank until the temperature returns to the target setting.

4. *Why doesn't the unit start when the temperature of the stored water decreases?*

Answer: To ensure that the unit is not turning on and off too frequently, the controller is set to ignore temperature drops of less than 5°C. When that limit is reached, the unit will start.

5. *Why does the temperature drop so rapidly in the tank?*

Answer: If an unusual amount of hot water is drawn off such that the tank is depleted, then the cold (inlet) water will reach the tank-top sensor and the reading will drop rapidly.

6. *Why is there still hot water available when the temperature display drops significantly?*

Answer: The temperature normally displayed on the unit is the outlet temperature. In fact, there's about 1/5 of the tank above the sensor which will be of a higher, or equal, temperature to that displayed.

7. *Why does the fan continue to operate after the compressor has stopped?*

Answer: Sometimes the unit needs to defrost and the fan will continue running to achieve this. The lower the ambient temperature, the more often this will occur and is a natural operation of a heat pump.

8. *Why is the heating period so long?*

Answer: If the unit is set to Economic mode and when both the ambient temperature and inlet water are low, the unit will need to run for a longer period to reach the target temperature.

11.0 GUARANTEE

Should any factory fitted Temperature and/or Pressure Relief Valve(s) or other safety devices be tampered with or removed or any recommended Temperature or Pressure Relief Valves/safety devices not be fitted, your warranty/guarantee will be invalidated. Neither the Distributor nor Manufacturer shall be responsible for any damage resulting from the tampering, howsoever caused, save where such exclusion is unlawful.

11.1 Guarantee Terms

ESP warrants/guarantees the electrical parts, thermal controls and valves relating to the cylinder for a period of one year from the date of purchase, with the exception of normal wear and tear including any damage caused as a result of lime scale deposits.

The stainless steel vessel forming part of the cylinder is warranted/guaranteed for a period of five years against faulty manufacture or materials provided that:

- i) It has been properly installed by a competent installer as per the instructions and recommendations contained in this manual and all relevant Codes of Practice and Regulations in force at the time of installation.
- ii) Any disinfection has been carried out in accordance with EN806.
- iii) It has not been modified in any way other than by ESP.
- iv) It has only been used for the storage of wholesome water.
- v) It has not been installed in a location liable to be subjected to frost, nor has it been tampered with or been subjected to misuse or neglect.
- vi) No factory fitted parts have been removed for unauthorised repair or replacement
- vii) Within 45 days of purchase the user completes and returns the certificate supplied to register the product.

The compressor in the heat pump is warranted/guaranteed for 2 years from the date of purchase. Remaining parts of the heat pump are warranted/ guaranteed for 1 year from the date of purchase.

Evidence of purchase and date of supply must be submitted with any warranty/guarantee claim.

This warranty/guarantee is not valid for installations outside the United Kingdom or the Republic of Ireland.

Any warranty/guarantee is for replacement parts only.

The purchaser of the unit acknowledges that he/she has seen ESP's conditions of supply and has understood them.

All of our units are RoHS approved units.

This guarantee does not affect your statutory rights.

12.0 ENVIRONMENTAL INFORMATION

This product is made from many recyclable materials, therefore at the end of its useful life, it should be disposed of at a Local Authority Recycling Centre in order to realise the full environmental benefits.

Please note:

The pace of product development is such that we reserve the right to change product specifications without notice. We do, however, strive to ensure that all information in this leaflet is accurate at the time of publication.

13.0 SPARE PARTS

Earth Save Products Limited carries spare parts for all the units it supplies. We strive to ensure that spare parts are readily available at competitive prices. Should you need any spare parts and we will be pleased to give you a quotation. Please call 00 44 (0)1865 40 77 69.

14.0 FACTORY SET PARAMETERS



The following is a list of the factory set parameters. They should not require changing, indeed, changing any of them could damage the unit and, in extreme circumstances, could be dangerous. They should not be changed without consultation with the ESP Technical Team.

NO.	Meaning	Code	Para.	Value	Range
1	To set the use of /005 (OUT5) port	/	/01	0	0~4
2	To set the use of /006 (CN6) port		/02	0	0~3
3	Whether enable ambient temperature compensation	C	C01	0	0-No/1-Yes
4	Maximum offset of compensation		C02	5	1~10℃
5	Compensating factor		C03	-1	-5~5℃
6	The ambient temperature of starting compensation		C04	5	-30~30℃
7	Start defrost temperature	d	d01	-3℃	-30~0℃
8	End defrost temperature		d02	13℃	2~30℃
9	Delay time between 2 defrosting cycle		d03	45min	30~90min
10	Max. duration time of defrosting		d04	8min	1~12min
11	Min. duration of economic defrosting		d05	3min	1~10min
12	Defrosting mode		d06	0	0~2
13	Ambient temperature of converting defrosting mode		d07	4℃	-10~20℃
14	Disinfect setting temperature per week	g	g01	60℃	30~70℃
15	Disinfect running time		g02	0min	0~90min
16	The time to start high-temperature disinfection		g03	0h	0~23h
17	The cycle time of high-temperature disinfection		g04	7D	7~99D
16	Electronic expansion valve mode	E	E01	1	0-Manual/1-Auto
18	Superheat temperature target		E02	(default)	-20~20℃
19	Expansion valve initial position		E03	350	0~500
20	Expansion valve minimum position		E04	100	0~500
21	Expansion valve position during defrosting		E05	480	0~500
22	Automatic restarting	H	H01	1	0-No/1-Yes
25	The advance time of water pump starting up		H04	1	1~30min
28	The temperature unit		H07	0	0-℃/1-℉
29	Which sensor is used to control solar mode	n	n01	0	0-bottom/ 1-top
30	The minimum running time of solar water pump		n02	15min	1~30min
31	Temperature differential of solar water pump starting		n03	5℃	0~20℃
32	Whether enable the mode of temperature drop at night		n04	0	0-No/1-Yes
33	The time to start temperature drop at night		n05	00h	00~23h
34	The time to end temperature drop at night		n06	06h	00~23h
35	The start value of temperature drop at night		n07	70℃	40~90℃
36	The end differential of temperature drop at night		n08	10℃	1~40℃
37	The set point of solar drainage valve		n09	80℃	50~90℃
38	The stop point of solar water pump		n10	84℃	50~90℃
39	Whether enable solar water pump operate independently		n11	0	0-No/1-Yes

40	Inlet water temperature set point	r	r01	55℃	10~60℃
42	The temperature differential in heating mode		r03	5℃	1~20℃
43	Whether enable set point of electric heater		r04	0	0-No/1-Yes
44	The set point of electrical heater		r05	55℃	30~90℃
45	The delay time of starting up the electrical heater		r06	200min	0~450min
46	Whether enable electrical-heater replace compressor		r07	1	0-No/1-Yes
47	The ambient temperature when electrical-heater replace compressor		r08	-5℃	-20~10℃
48	The ambient temperature of electrical heater start without delay		r09	10℃	0~30℃
49	The ambient temperature of electrical heater start with delay		r10	25℃	10~40℃
50	The running time of circulate pump		r11	60s	0~255s
51	The ambient temperature of compressor stopped by force		r12	-15℃	-5~-30℃
54	Remote on/off switch status		s	S01	/
55	OHP switch (Over heat protection) status	S02		/	CL/O/P
56	System low pressure switch status	S03		/	CL/O/P
57	System high pressure switch status	S04		/	CL/O/P
58	Electrical heater time test switch status	S05		/	CL/O/P
59	Water flow switch status	S06		/	CL/O/P
60	Ambient temperature	t	t01	/	-9~99℃
61	Bottom temperature of the tank		t02	/	-9~99℃
62	Top temperature of the tank		t03	/	-9~99℃
63	Coil temperature		t04	/	-9~99℃
64	Suction temperature		t05	/	-9~99℃
65	Solar tank temperature		t06	/	-9~99℃
66	Compressor	o	O01	/	ON/OFF
67	Electrical heater		O02	/	ON/OFF
68	4-way valve		O03	/	ON/OFF
69	Fan high speed		O04	/	ON/OFF
70	Fan high speed/ circulate pump/ solar pump		O05	/	ON/OFF
71	Running indicator light/ circulate pump/ solar pump		O06	/	ON/OFF
72	EEV position		O07	/	0~500